

# SLP010S-12U

## High Efficiency Monocrystalline PV Module

**30 CELL**  
MONOCRYSTALLINE MODULE

**10W**  
POWER OUTPUT

**20.00%**  
MODULE EFFICIENCY

**5%**  
POSITIVE TOLERANCE

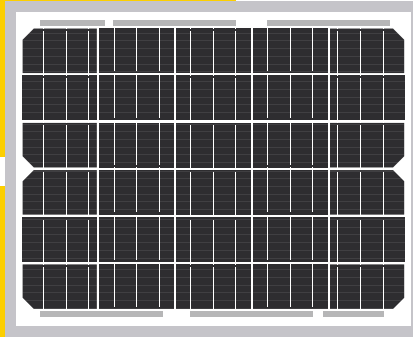

- Nominal 12V DC for standard output.
- Outstanding low-light performance.
- Heavy-duty anodized frames.
- High transparent low-iron, tempered glass.
- Designed to withstand high wind pressures, hail and heavy snow.
- Quality aesthetic appearance.



**High Efficiency**

Module Efficiency improved through advanced cell technology and manufacturing capabilities



**High PID Resistance**

Advanced cell technology and qualified materials lead to high resistance to PID



**Withstands Harsh Environment**

High PID resistance  
5400 Pa positive load  
2400 Pa negative load  
Salt mist (IEC 61701)

### Performance Warranty

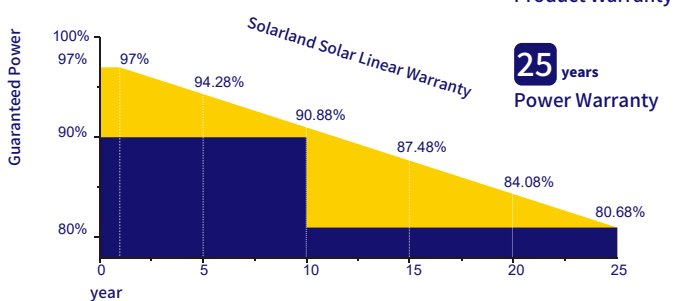

Product Certificate	IEC 61215, IEC 61730
Management Certificate	ISO 9001: 2016
Other certificate	Fire Rating Class C, TÜV Rheinland
Positive mechanical load	>5400Pa
Positive Power Tolerance	0~+5W
Warranty Information	2 Year Product Warranty and Workmanship

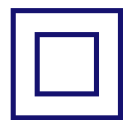

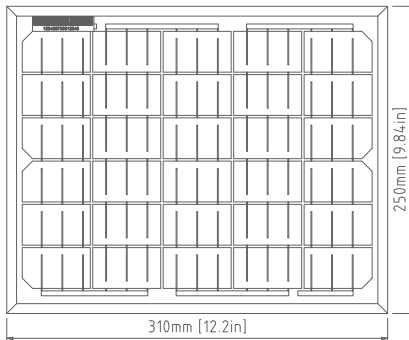

Electrical Characteristics	SLP010S-12U
Product code	010031202A
Maximum power (Pmax)	10W
Voltage at Pmax (Vmp)	17.37V
Current at Pmax (Imp)	0.69A
Open-circuit voltage (Voc)	20.04V
Short-circuit current (Isc)	0.73A
Temperature coefficient of Voc	-(80±10)mV/°C
Temperature coefficient of Isc	(0.065±0.015)%/°C
Temperature coefficient of power	-(0.5±0.05)%/°C
NOCT (Air 20°C; Sun 0.8kW/m² wind 1m/s)	47±2°C
Operating temperature	-40°C to 85°C
Maximum system voltage	1000V DC
Power tolerance	± 5%

\*STC: Irradiance 1000W/m², AM1.5 spectrum, module temperature 25°C  
\*NOCT: Nominal operating cell temperature (the data is only for reference)

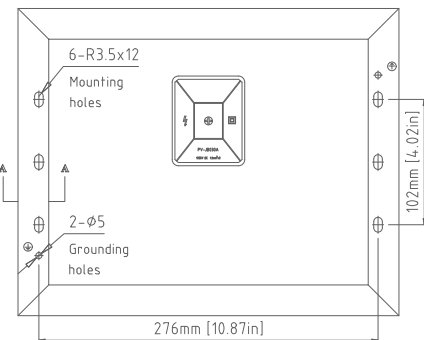

Specifications	SLP010S-12U
Cells	Monocrystalline silicon solar cell
No. of cells and connections	30(5X6)
Module dimension	250mm[9.84in.]x310mm[12.20in.]x30mm[1.18in.]
Weight	1.09kg[2.41lbs]
Packing information(Carton)	300mm[11.81in.]x360mm[14.17in.]x80mm[3.15in.]/(1pc/ctn)

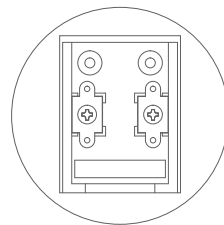

Junction Box  
Top View (Lid Open)

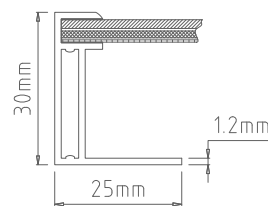

Section A-A

Dimensions in brackets are in inches.  
Un-bracketed dimensions are in millimeters.  
Unit: mm[in.]

Characteristics

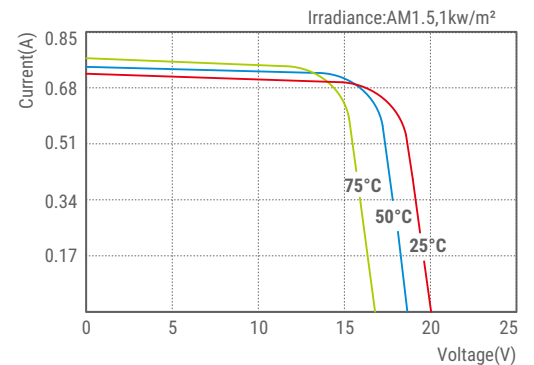

SLP010S-12U I-V Curves