

# SLP020-24U

## High Efficiency Polycrystalline PV Module

- Nominal 24V DC for standard output.
- Outstanding low-light performance.
- Heavy-duty anodized frames.
- High transparent low-iron, tempered glass.
- Designed to withstand high wind pressures, hail and heavy snow.
- Quality aesthetic appearance.

**72 CELL**  
POLYCRYSTALLINE MODULE

**20W**  
POWER OUTPUT

**20.00%**  
MODULE EFFICIENCY

**5%**  
POSITIVE TOLERANCE

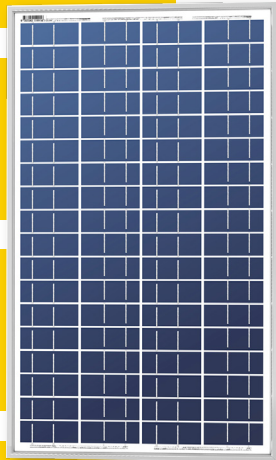

**High Efficiency**

Module Efficiency improved through advanced cell technology and manufacturing capabilities



**High PID Resistance**

Advanced cell technology and qualified materials lead to high resistance to PID



**Withstands Harsh Environment**

High PID resistance  
5400 Pa positive load  
2400 Pa negative load  
Salt mist (IEC 61701)

### Performance Warranty

**10** years  
Product Warranty

**25** years  
Power Warranty

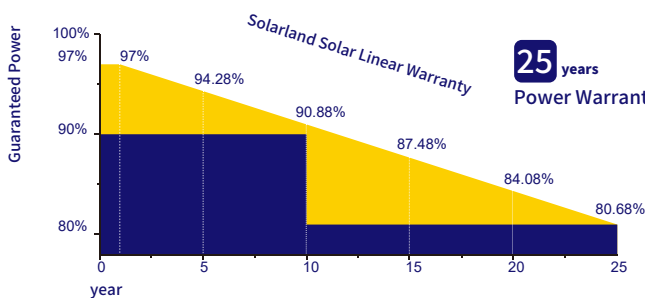

Product Certificate	IEC 61215, IEC 61730
Management Certificate	ISO 9001: 2016
Other certificate	Fire Rating Class C, TÜV Rheinland
Positive mechanical load	>5400Pa
Positive Power Tolerance	0~+5W
Warranty Information	2 Year Product Warranty and Workmanship

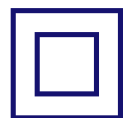

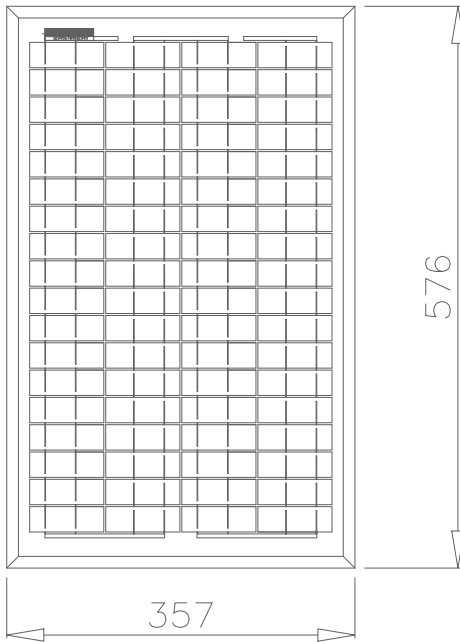

Electrical Characteristics	SLP020-24U
Product code	020012403
Maximum power (Pmax)	20W
Voltage at Pmax (Vmp)	34.4V
Current at Pmax (Imp)	0.58A
Open-circuit voltage (Voc)	43.2V
Short-circuit current (Isc)	0.68A
Temperature coefficient of Voc	-(80±10)mV/°C
Temperature coefficient of Isc	(0.065±0.015)%/°C
Temperature coefficient of power	-(0.5±0.05)%/°C
NOCT (Air 20°C; Sun 0.8kW/m² wind 1m/s)	47±2°C
Operating temperature	-40°C to 85°C
Maximum system voltage	1000V DC
Power tolerance	± 5%

\*STC: Irradiance 1000W/m², AM1.5 spectrum, module temperature 25°C  
\*NOCT: Nominal operating cell temperature (the data is only for reference)

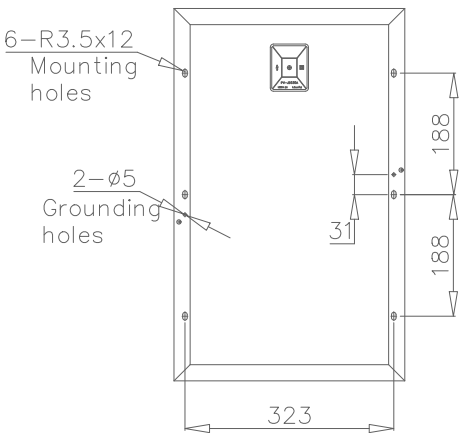

Specifications	SLP020-24U
Cells	Polycrystalline silicon solar cell
No. of cells and connections	72(4X18)
Module dimension	576mm[22.68in.]x357mm[14.06in.]x30mm[1.18in.]
Weight	2.55kg[5.62lbs]
Packing information(Carton)	605mm[23.81in.]x215mm[8.46in.]x390mm[15.35in.]/(5pcs/ctn)

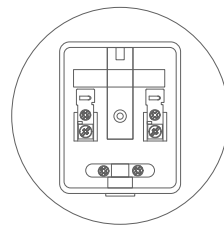

Junction Box  
Top View (Lid Open)

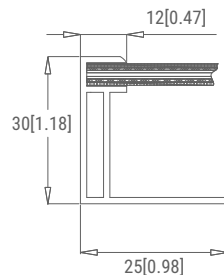

Section A-A

Characteristics

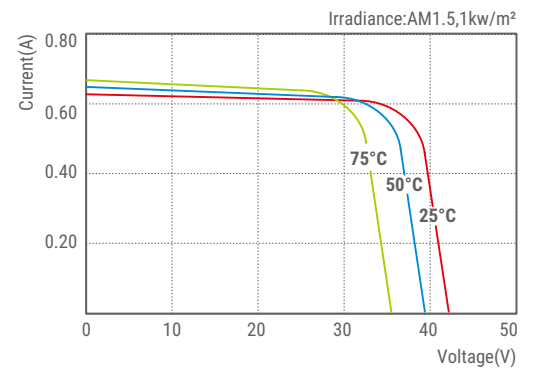

SLP020-24U I-V Curves

Dimensions in brackets are in inches.  
Un-bracketed dimensions are in millimeters.  
Unit: mm[in.]