

# SLP030-12U

## High Efficiency Polycrystalline PV Module

- Nominal 12V DC for standard output.
- Outstanding low-light performance.
- Heavy-duty anodized frames.
- High transparent low-iron, tempered glass.
- Designed to withstand high wind pressures, hail and heavy snow.
- Quality aesthetic appearance.

**36 CELL**  
POLYCRYSTALLINE MODULE

**30W**  
POWER OUTPUT

**20.00%**  
MODULE EFFICIENCY

**5%**  
POSITIVE TOLERANCE

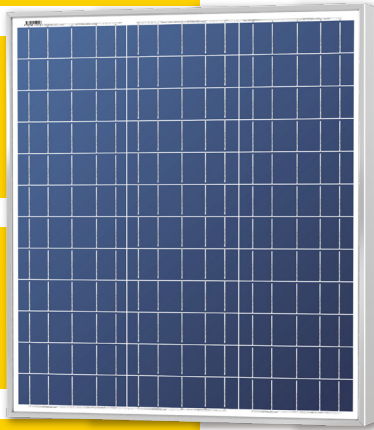

**High Efficiency**

Module Efficiency improved through advanced cell technology and manufacturing capabilities



**High PID Resistance**

Advanced cell technology and qualified materials lead to high resistance to PID



**Withstands Harsh Environment**

High PID resistance  
5400 Pa positive load  
2400 Pa negative load  
Salt mist (IEC 61701)

### Performance Warranty

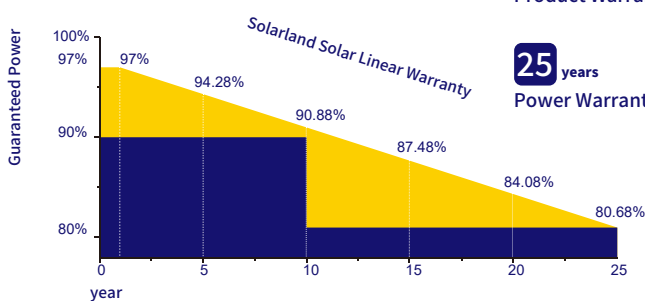

**10 years**  
Product Warranty

**25 years**  
Power Warranty

Product Certificate	IEC 61215, IEC 61730
Management Certificate	ISO 9001: 2016
Other certificate	Fire Rating Class C, TÜV Rheinland
Positive mechanical load	>5400Pa
Positive Power Tolerance	0~+5W
Warranty Information	2 Year Product Warranty and Workmanship

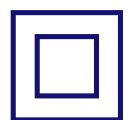

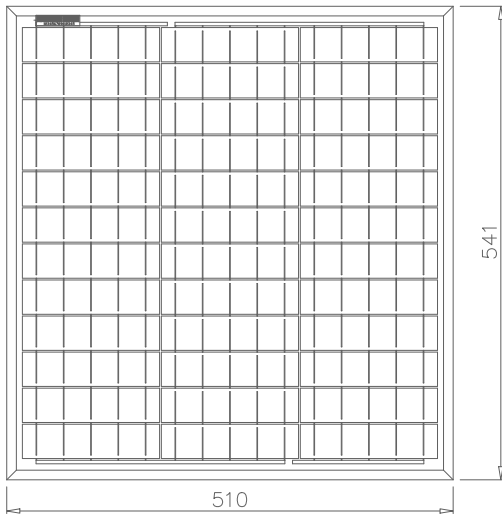

Electrical Characteristics	SLP030-12U
Product code	030011209
Maximum power (Pmax)	30W
Voltage at Pmax (Vmp)	17.2V
Current at Pmax (Imp)	1.74A
Open-circuit voltage (Voc)	21.6V
Short-circuit current (Isc)	1.93A
Temperature coefficient of Voc	-(80±10)mV/°C
Temperature coefficient of Isc	(0.065±0.015)%/°C
Temperature coefficient of power	-(0.5±0.05)%/°C
NOCT (Air 20°C; Sun 0.8kW/m² wind 1m/s)	47±2°C
Operating temperature	-40°C to 85°C
Maximum system voltage	1000V DC
Power tolerance	± 5%

\*STC: Irradiance 1000W/m², AM1.5 spectrum, module temperature 25°C  
 \*NOCT: Nominal operating cell temperature (the data is only for reference)

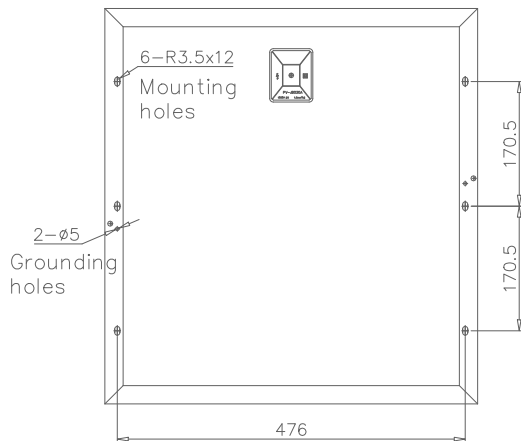

Specifications	SLP030-12U
Cells	Polycrystalline silicon solar cell
No. of cells and connections	36(3X12)
Module dimension	541mm[21.30in.]x510mm[20.08in.]x30mm[1.18in.]
Weight	3.29kg[7.26lbs]
Packing information(Carton)	585mm[23.03in.]x555mm[21.85in.]x95mm[3.74in.]/(2pcs/ctn)

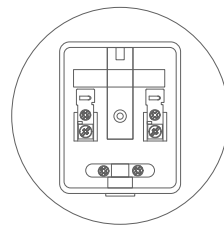

Junction Box  
Top View (Lid Open)

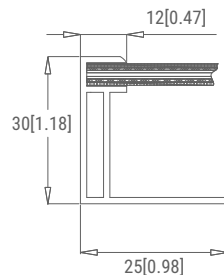

Section A-A

Characteristics

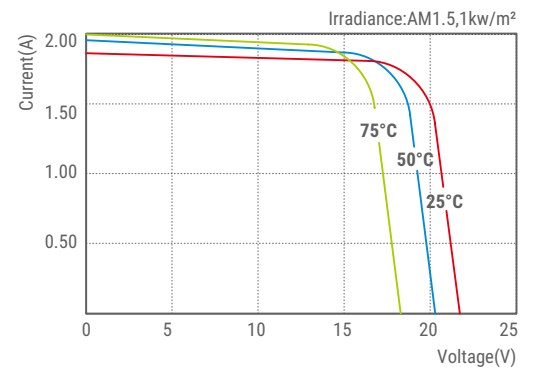

SLP030-12U I-V Curves

Dimensions in brackets are in inches.  
 Un-bracketed dimensions are in millimeters.  
 Unit: mm[in.]