

SLP050-12C1D2

High Efficiency Polycrystalline PV Module

36 CELL
POLYCRYSTALLINE MODULE

50W
POWER OUTPUT

20.00%
MODULE EFFICIENCY

5%
POSITIVE TOLERANCE

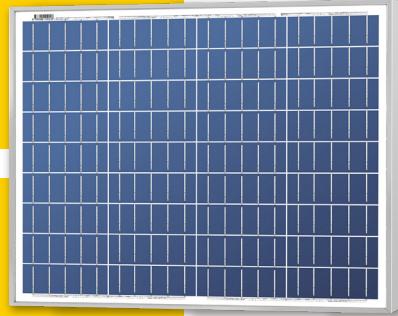

- Nominal 12V DC for standard output.
- Outstanding low-light performance.
- Heavy-duty anodized frames.
- High transparent low-iron, tempered glass.
- Designed to withstand high wind pressures, hail and heavy snow.
- Quality aesthetic appearance.



High Efficiency

Module Efficiency improved through advanced cell technology and manufacturing capabilities



High PID Resistance

Advanced cell technology and qualified materials lead to high resistance to PID



Withstands Harsh Environment

High PID resistance
5400 Pa positive load
2400 Pa negative load
Salt mist (IEC 61701)

Performance Warranty

10 years
Product Warranty

25 years
Power Warranty

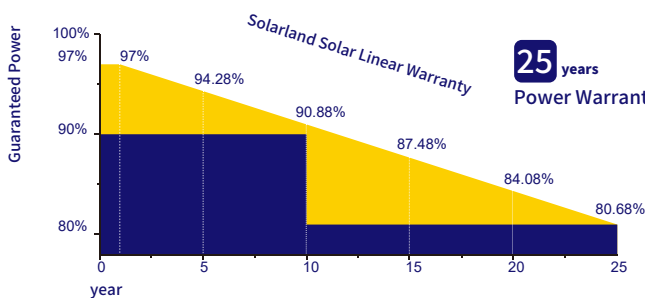

Product Certificate	IEC 61215, IEC 61730, C1D2 - Class 1, Division 2, UL1703, cUL1703, Hazardous Environments
Management Certificate	ISO 9001: 2016
Other certificate	Fire Rating Class C, TÜV Rheinland
Positive mechanical load	>5400Pa
Positive Power Tolerance	0~+5W
Warranty Information	2 Year Product Warranty and Workmanship



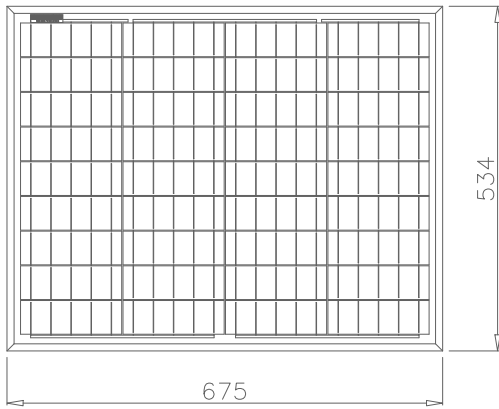

Electrical Characteristics	SLP050-12C1D2
Product code	050011263
Maximum power (Pmax)	50W
Voltage at Pmax (Vmp)	18.64V
Current at Pmax (Imp)	2.68A
Open-circuit voltage (Voc)	22.18V
Short-circuit current (Isc)	2.85A
Temperature coefficient of Voc	-(80±10)mV/°C
Temperature coefficient of Isc	(0.065±0.015)%/°C
Temperature coefficient of power	-(0.5±0.05)%/°C
NOCT (Air 20°C; Sun 0.8kW/m² wind 1m/s)	47±2°C
Operating temperature	-40°C to 85°C
Maximum system voltage	1000V DC
Power tolerance	± 5%

*STC: Irradiance 1000W/m², AM1.5 spectrum, module temperature 25°C
*NOCT: Nominal operating cell temperature (the data is only for reference)

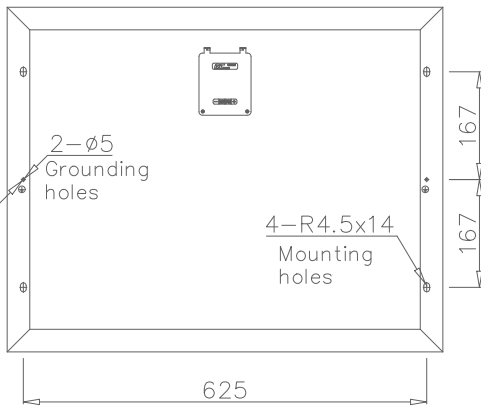

Specifications	SLP050-12C1D2
Cells	Polycrystalline silicon solar cell
No. of cells and connections	36(4X9)
Module dimension	534mm[21.02in.]x675mm[26.57in.]x35mm[1.38in.]
Weight	4.30kg[9.49lbs]
Packing information(Carton)	720mm[28.35in.]x580mm[22.83in.]x105mm[4.13in.]/(2pcs/ctn)

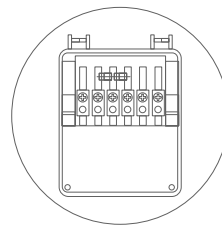

Junction Box
Top View (Lid Open)

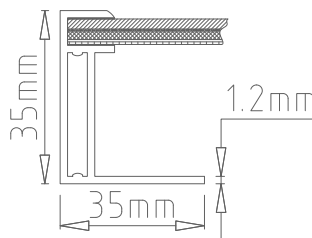

Section A-A

Dimensions in brackets are in inches.
Un-bracketed dimensions are in millimeters.
Unit: mm[in.]

Characteristics

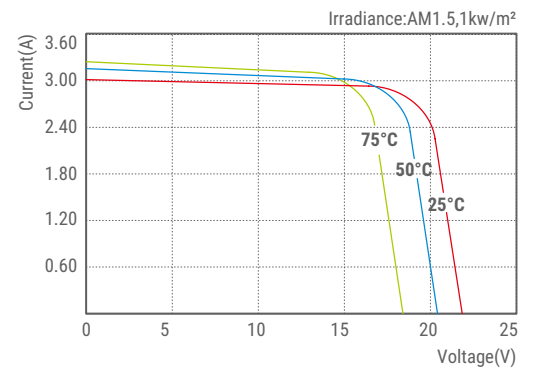

SLP050-12C1D2 I-V Curves