

SLP050-12U-MC

High Efficiency Polycrystalline PV Module

36 CELL
POLYCRYSTALLINE MODULE

50W
POWER OUTPUT

20.00%
MODULE EFFICIENCY

5%
POSITIVE TOLERANCE

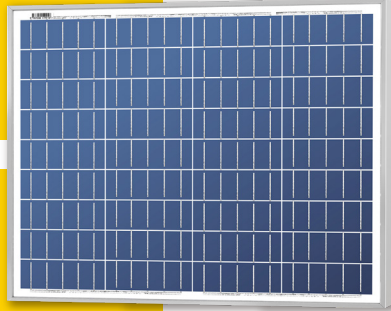

- Nominal 12V DC for standard output.
- Outstanding low-light performance.
- Heavy-duty anodized frames.
- High transparent low-iron, tempered glass.
- Designed to withstand high wind pressures, hail and heavy snow.
- Quality aesthetic appearance.



High Efficiency

Module Efficiency improved through advanced cell technology and manufacturing capabilities



High PID Resistance

Advanced cell technology and qualified materials lead to high resistance to PID



Withstands Harsh Environment

High PID resistance
5400 Pa positive load
2400 Pa negative load
Salt mist (IEC 61701)

Performance Warranty

10 years
Product Warranty

25 years
Power Warranty

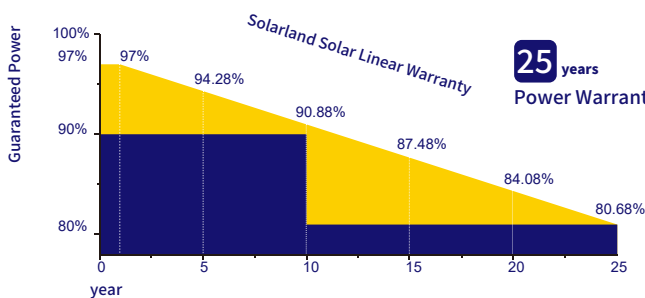

| | |
|--------------------------|---|
| Product Certificate | IEC 61215, IEC 61730 |
| Management Certificate | ISO 9001: 2016 |
| Other certificate | Fire Rating Class C, TÜV Rheinland |
| Positive mechanical load | >5400Pa |
| Positive Power Tolerance | 0~+5W |
| Warranty Information | 2 Year Product Warranty and Workmanship |

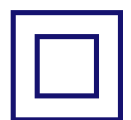

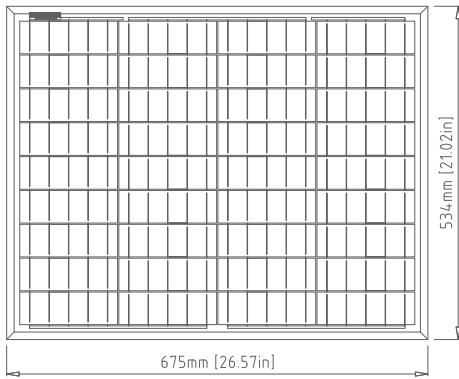

| Electrical Characteristics | SLP050-12U-MC |
|---|-------------------|
| Product code | 050011210 |
| Maximum power (Pmax) | 50W |
| Voltage at Pmax (Vmp) | 18.64V |
| Current at Pmax (Imp) | 2.68A |
| Open-circuit voltage (Voc) | 22.18V |
| Short-circuit current (Isc) | 2.85A |
| Temperature coefficient of Voc | -(80±10)mV/°C |
| Temperature coefficient of Isc | (0.065±0.015)%/°C |
| Temperature coefficient of power | -(0.5±0.05)%/°C |
| NOCT (Air 20°C; Sun 0.8kW/m² wind 1m/s) | 47±2°C |
| Operating temperature | -40°C to 85°C |
| Maximum system voltage | 1000V DC |
| Power tolerance | ± 5% |

*STC: Irradiance 1000W/m², AM1.5 spectrum, module temperature 25°C
*NOCT: Nominal operating cell temperature (the data is only for reference)

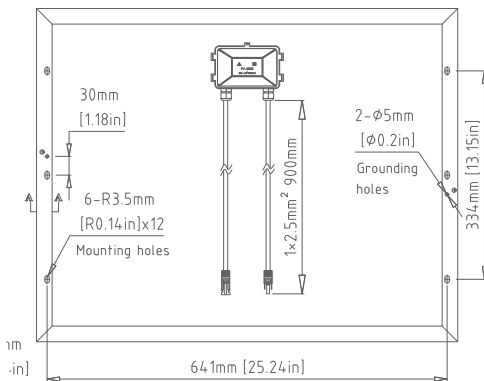

| Specifications | SLP050-12U-MC |
|------------------------------|--|
| Cells | Polycrystalline silicon solar cell |
| No. of cells and connections | 36(4X9) |
| Module dimension | 534mm[21.02in.]x675mm[26.57in.]x30mm[1.18in.] |
| Weight | 4.20kg[9.26lbs] |
| Packing information(Carton) | 720mm[28.35in.]x580mm[22.83in.]x95mm[3.74in.]/(2pcs/ctn) |

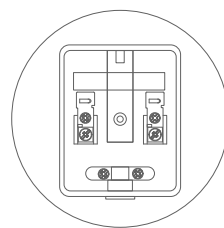

Junction Box
Top View (Lid Open)

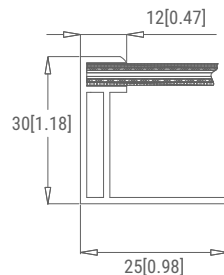

Section A-A

Dimensions in brackets are in inches.
Un-bracketed dimensions are in millimeters.
Unit: mm[in.]

Characteristics

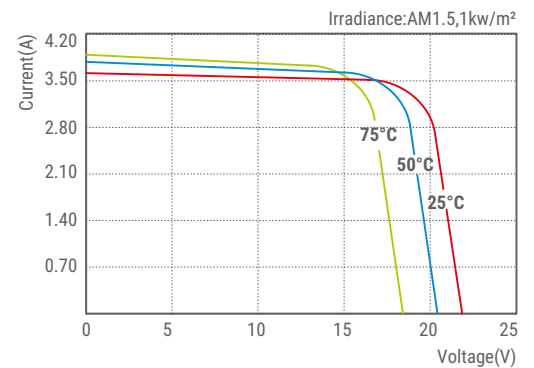

SLP050-12U-MC I-V Curves